

GRU
A
T
O
R
R
E

GA 245

GRU AUTOMATICA CON
MONTAGGIO IDRAULICO

GA compact



GX



GHS topless



25 km/h

RAPIDE

VELOCE

FAST

SCHNELL

RÁPIDA

80 km/h

FBGRU
LIFT YOUR GOALS!

Kurth

Vermietung, Verkauf und Service
von Schnellbaukranen der Firma
FBGRU / Wendel

Mülheimer Heide 15
53945 Blankenheim
Telefon: +49 (0) 24 49 / 91 77 6-0

info@kurth-autokrane.de
www.kurth-autokrane.de

CE

FEM 1.001 - A3
EN 14439 - C25

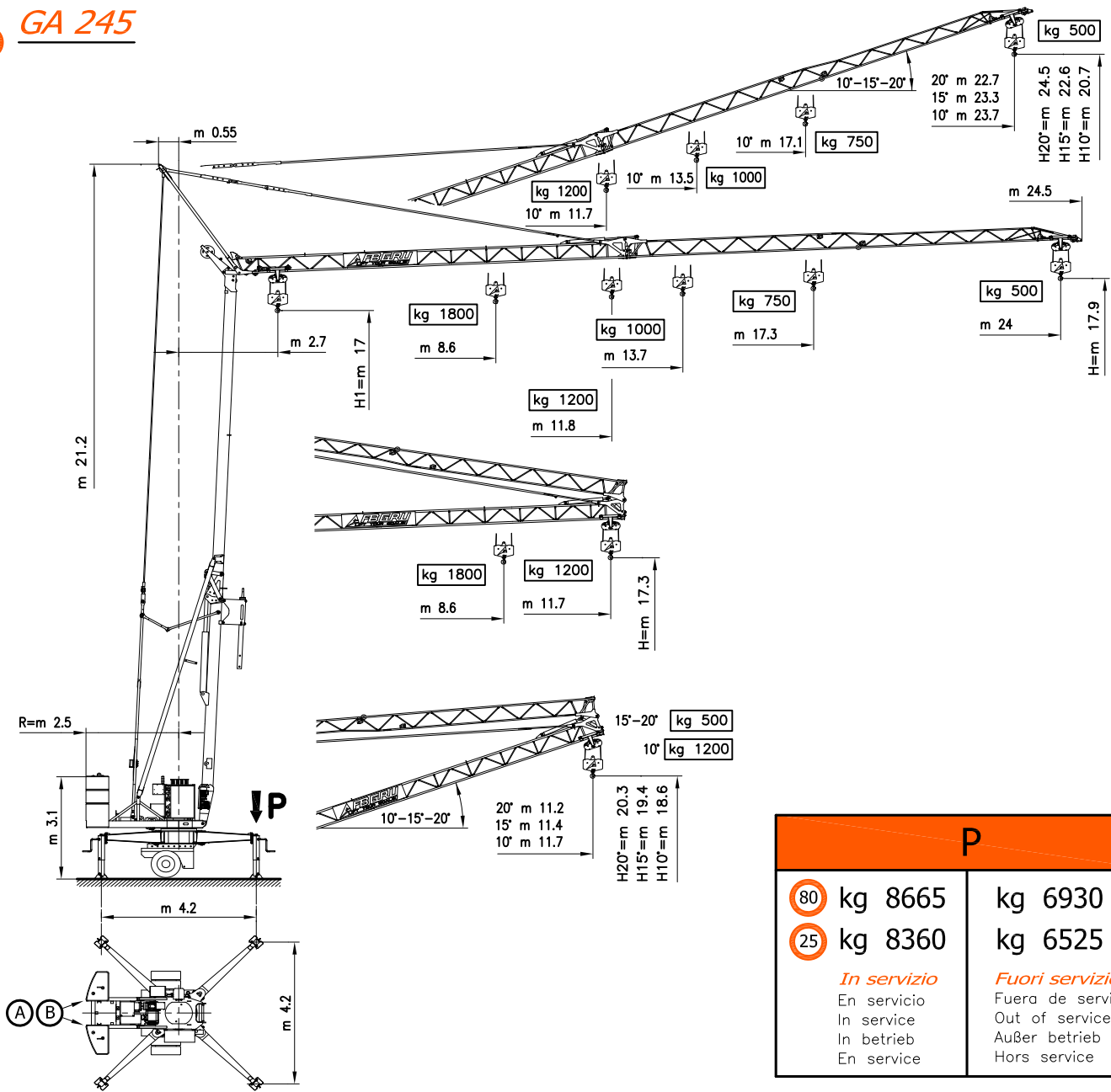

P	
80	kg 8665
25	kg 8360
<i>In servizio</i>	
En servicio	
In service	
In betrieb	
En service	
80	kg 6930
25	kg 6525
<i>Fuori servizio</i>	
Fuera de servicio	
Out of service	
Außer betrieb	
Hors service	

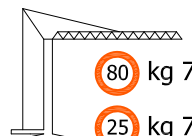
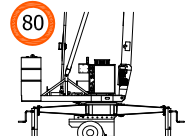
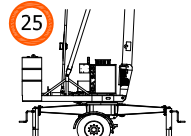
A			B			P	
80	(A)	(B)	80	(A)	(B)	 80 kg 7650 25 kg 7060	
	N° 2x2200	N° 4x600 N° 2x1000		N° 2x2200 N° 1x300	N° 4x600 N° 2x1000 N° 1x300		
kg 12050			kg 11760				

LA GRU LA GRÚA — CRANE
KLAN — GRUE



MOVIMENTO MOVIMIENTO MOVEMENT BEWEGUNG MOUVEMENT	ALIMENTAZIONE ALIMENTACION OPERATING VOLTAGE BETRIEBSSPANNUNG TENSION DE SERVICE	PRESTAZIONI FUNCIONAMIENTOS PERFORMANCES LEISTUNGEN EXÉCUTIONS	
---	---	---	---

SOLLEVAMENTO ELEVACION — HOISTING HEBEN — LEVAGE INVERTER 	230 V 50 Hz	3 kW	1 ^a m/1' - kg	2 ^a m/1' - kg	3 ^a m/1' - kg	4 ^a m/1' - kg	kW 5.5
		4.5 kW	4	7	12	25	
	400 V 50 Hz	4	12	25			
		1800	1800	1200	500		
		4	14	25	39		
		1800	1800	1200	750		

CARRELLO CARRILLO — JIB TROLLEY LAUFKATZE — DISTRIBUTION INVERTER 	230 - 400 V 50 Hz	1 ^a m/1'	2 ^a m/1'	3 ^a m/1'	kW 1.8
		12	20	38	

ROTAZIONE ROTACION — SLEWING DREHEN — ORIENTATION INVERTER 	230 - 400 V 50 Hz	1 ^a g/1'	2 ^a g/1'	3 ^a g/1'	kgm 1.2
		0 → 0.19	0.19 → 0.46	0.46 → 0.93	



Conforme alle direttive
CEE sul livello acustico
2000/14/CE

Conforme con las directivas
CEE sobre el nivel acustico

In compliance with the EEC
instructions on noise level

Gemass EWG-Richtlinien für
den Schall-Leistungspegel

Conforme aux directives CEE
sur le niveau acoustique

CURVE DI CARICO

**CURVAS DE CARGAS — LOAD DIAGRAMS
LASTKURVEN — COURBES DE CHARGES**

V24 

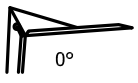
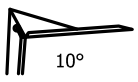
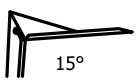
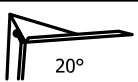
 0°	m	2.7	5	8.6	9	9.9	11	12	13.7	15	16	17.3	18	19	20	21	22	23	24	
	kg	1800			1692	1500	1318	1182	1000	896	826	750	714	667	626	589	556	526	500	
 10°	m	2.7	5	8	9	10	11.7	12	13.5	15	16	17.1	18	19	20	21	22	23	23.7	
	kg	1200						1162	1000	883	815	750	705	660	619	583	551	521	500	
 15°	m	2.7	5	8	10	15	20	23.3												
	kg	500																		
 20°	m	2.7	5	8	10	15	20	22.7												
	kg	500																		

(0 - 1800 kg)

POTENZA RICHIESTA

**POTENCIA-ELECTRICA NECESARIA — NECESSARY ELECTRIC POWER
KRAFTBEDARF — PUISSANCE ELECTRIQUE NECESSAIRE**

	SOLLEVAMENTO ELEVACION — HOISTING — HEBEN — LEVAGE	kg 1800
	3 kW - 4.5 kW 230 V - 50 Hz	8 kW 400 V - 50 Hz

GA 245

TRASPORTO TRANSPORTE — TRANSPORT
TRANSPORT — TRANSPORT

80
km/h

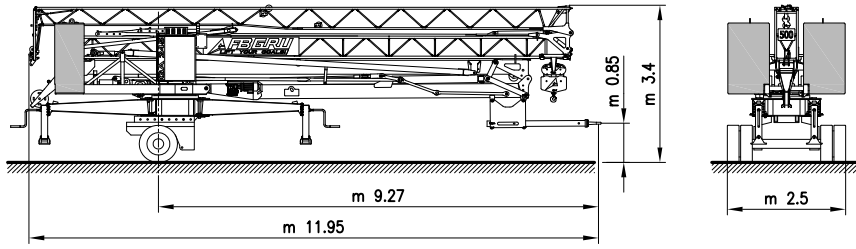

MONTAGGIO MONTAJE — ERECTION
MONTAGE — MONTAGE

